

JH. Living Vocoder  
 (c) J. Haible 2010  
 All Rights reserved  
 Errors excepted  
 Channel 18

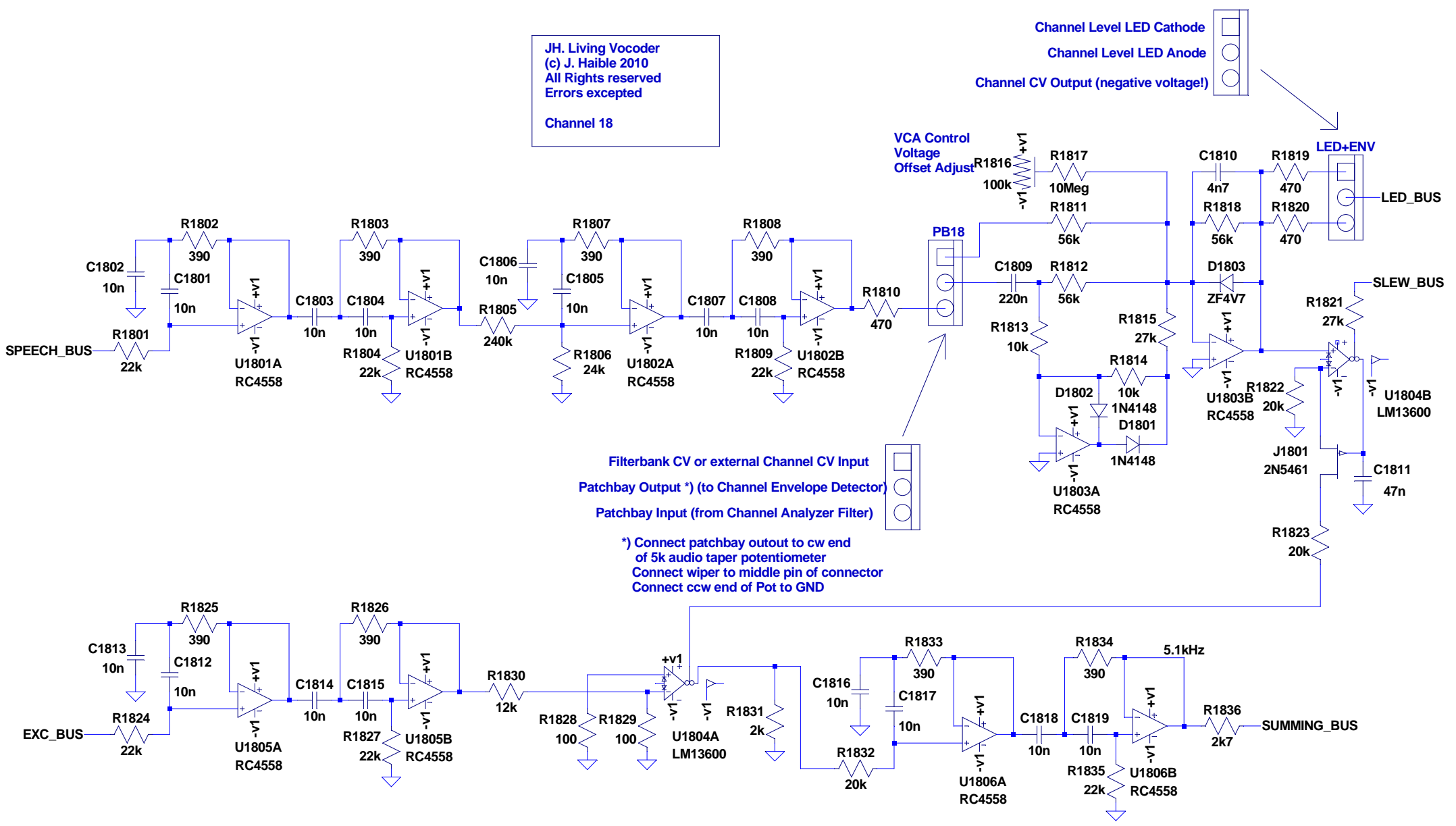

Channel Level LED Cathode  
 Channel Level LED Anode  
 Channel CV Output (negative voltage!)

Filterbank CV or external Channel CV Input  
 Patchbay Output \*) (to Channel Envelope Detector)  
 Patchbay Input (from Channel Analyzer Filter)

\*) Connect patchbay output to cw end of 5k audio taper potentiometer  
 Connect wiper to middle pin of connector  
 Connect ccw end of Pot to GND