

**BP 2800Hz F7**

**BP 2224Hz C#7**

**BP 1760Hz A6**

**BP 1400Hz F6**

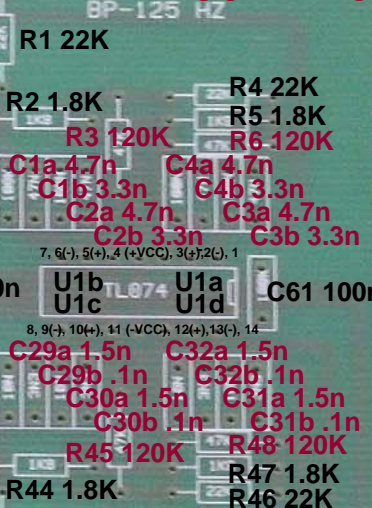
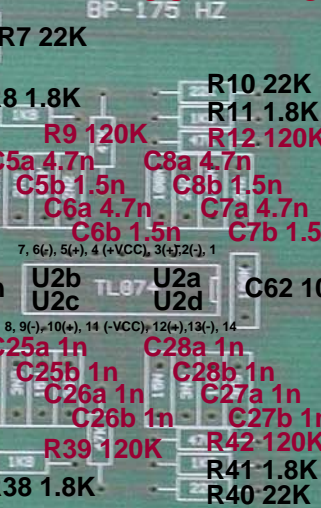
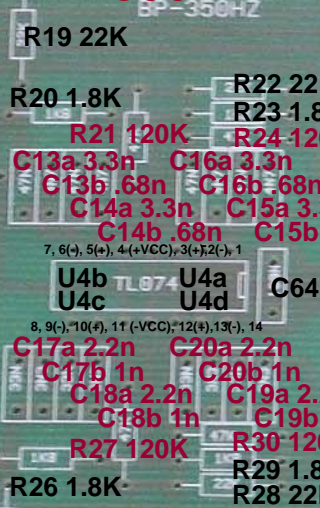

**BP 3520Hz A7**

**BP 4448Hz C#8**

**BP 5600Hz F8**

**BP 7040Hz A8**

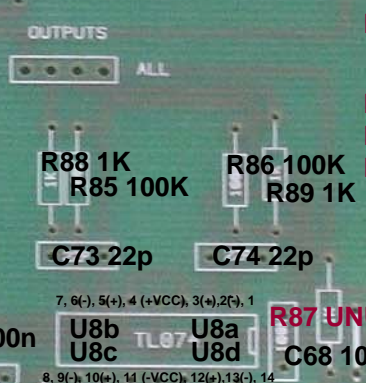
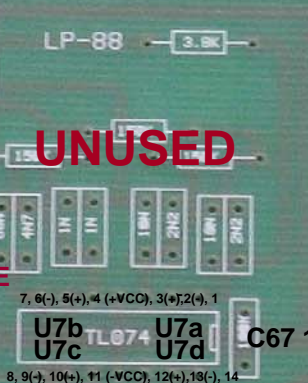

**BP 8896Hz C#9**

**BP 11200Hz F9**

**UNUSED**

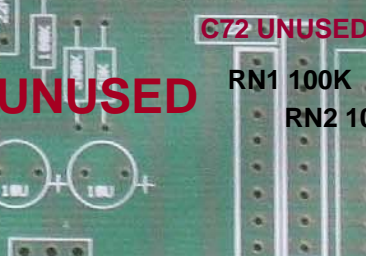
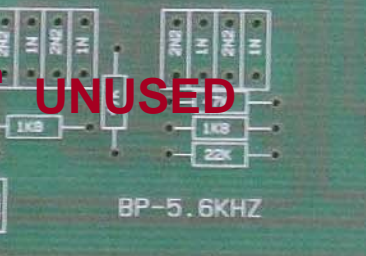
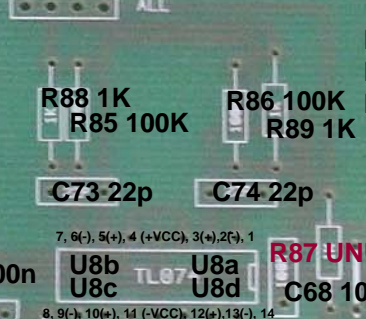
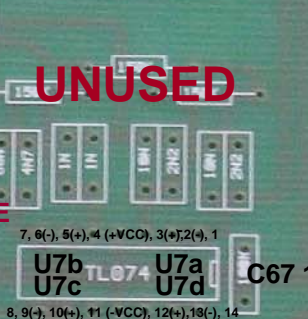
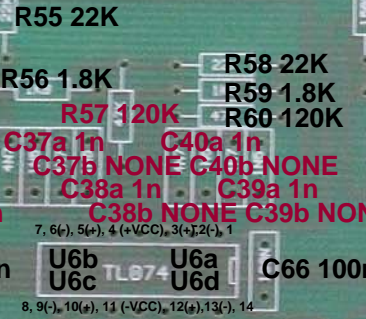
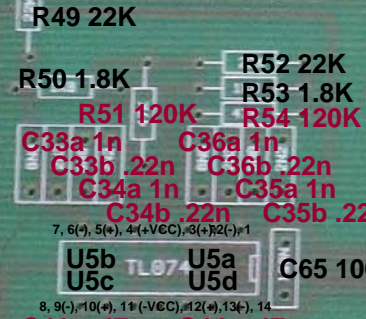

UL 94V-0

FIXED FILTER BANK

YUSYNTH - 2007

C69 22u (Reverse Polarity - PCB wrong)

R90 replace w/Ferrite Bead

R91 Replace w/ Ferrite Bead

C70 22u (Reverse Polarity - PCB wrong)

